



LUXURY SEAT HEATER KIT INSTALLATION MANUAL

Installation Instructions for Leather and Cloth Seating

- Read Carefully Before Starting Installation -

Limited Warranty

This Product is warranted to be free from defects in manufacturing and workmanship and is guaranteed to work for three years or 36,000 miles, or whichever occurs first. This Limited Warranty covers the repair or replacement of the seat heater components only and does not cover any costs related to or damage resulting from the installation of the seat heater. Seat heaters must only be used in the seat applications for which they were designed, tested and approved by Check Corporation, and failure to properly install the designated seat heated product, or improper installation or misuse of any component, will void this Limited Warranty. Installer shall indemnify and hold Check Corporation harmless from any and all installations contrary to automobile OEM, automobile dealership, and Check Corporation issued instructions.

MANUFACTURER'S LIMITED REPAIR/REPLACEMENT WARRANTY IS IN LIEU OF ALL OTHER WARRANTIES, EXPRESS OR IMPLIED, INCLUDING, BUT NOT LIMITED TO, ANY IMPLIED WARRANTY OF MERCHANTABILITY OR FITNESS FOR A PARTICULAR PURPOSE OR DUTIES OR WARRANTIES ARISING FROM A COURSE OF DEALING, USAGE OF TRADE OR COMMON LAW. IN NO EVENT SHALL MANUFACTURER BE LIABLE FOR PROXIMATE, INCIDENTAL, CONSEQUENTIAL OR OTHER DAMAGES, INCLUDING BUT NOT LIMITED TO DAMAGES FOR LOSS OF PROFITS OR PRODUCTION OR INJURY TO PERSON OR PROPERTY. THE CONSUMER OF THIS PRODUCT SHOULD CONTACT ITS INSTALLATION DEALER FOR ANY WARRANTY CLAIM AND RETURN WARRANTY CARD TO VALIDATE WARRANTY.

- Before You Start -

REVIEW ALL INSTALLATION INSTRUCTIONS AND PRODUCT WARNINGS BEFORE INSTALLATION!

- Seat Heaters Specification -

Check Corporation heating element assemblies are specific to each seat. They are designed to fit specific vehicle seats according to the model and production year of the vehicle.

- 12v automotive system (11 – 15 volts)
- Maximum power requirements vary by kit and range between 51W (3.7A @ 13.8V) and 84W (6.1A @ 13.8V).
- Temperature range measured at seat surface during normal operation **

Luxury (Temp II)	110°F (+/- 3 °F)	or 43.3°C
Luxury (Temp I)	104°F (+/- 3 °F)	or 40°C

- Heating elements meet FMVSS 302 flammability requirements
- Connectors are indexed to prevent improper mating

** Performance varies with seat materials used and the density and amount of sew foam between the heating elements and the surface of the seat. These numbers were measured with a 2003 Chevy Tahoe consisting of the luxury element assembly placed in an automotive seat with a leather cover.

- The skills You Need -

Automotive electrical experience or a basic understanding of electrical systems and the ability to disassemble and reassemble automotive seating is recommended.

Recommended tools:

- Multi-meter, terminal crimpers, wire strippers, screw driver, wrenches, electrical tape, marker or pencil, drill, wire cutters, torque, socket and allen wrenches, hog ring pliers, and utility knife, needle nose pliers, ratchet, deep socket, and 1" step drill bit.

- Parts list - FRONT SET HEATER SYSTEM

PARTS	SINGLE SEAT CUSHION & BACK	TWO SEATS CUSHION & BACK	TWO SEATS CUSHION & BACK & SINGLE ELEMENT
CUSHION ELEMENT	1	2	1
BACK ELEMENT	1	2	1
SINGLE ELEMENT	0	0	1
FUSE ADAPTER	1	1	1
SINGLE SWITCH PACK	1	0	0
TWIN SWITCH PACK	0	1	1
POWER HARNESS	1	1	1
TY-WRAPPS	12	12	12
GROUNDING SCREW	1	1	1
6FT EXTENSION HARNESS	1	1	1
9FT EXTENSION HARNESS	0	1	1
CONTROLLER	1	1	1
OWNERS MANUAL	1	1	1
INSTALLATION MANUAL	1	1	1

- Parts list - FRONT SET SWITCH PACKS

PARTS	SINGLE SWITCH PACK	TWIN SWITCH PACK
SWITCH	1	2
SINGLE SWITCH HARNESS	1	0
TWIN SWITCH HARNESS	0	1

NOTE:

The heating elements work best with a ¼" to ½" piece of foam between them and the seat cover material. Thicker foam will increase the heat up time. Normally foam is sewn into the seat cover at the factory.

- ! WARNING ! -

PLEASE READ BEFORE INSTALLING HEATING ELEMENT ASSEMBLIES!

- Some front passenger seats are outfitted with occupant detection sensors which are not compatible with any after-market seat heater. Consult with Check Corporation to determine the appropriate heating element assembly for each specific vehicle. See seat heater “selection guide” for details at www.checkcorp.com
- Heating elements should **NEVER** be installed onto foam where an occupant detection sensor is visible on the Top surface of the foam, even if the heating element would not touch the sensor. Heating elements are to be placed onto foam bun only. The heating elements may adversely affect or cause the sensors or airbag system to not function correctly, thereby causing severe injury or death.
- The provided fuse adapter must be used in the installation. Connecting to other power points will prevent the system from correctly monitoring power requirements. The heating elements must be connected to switched ignition power only.
- Never remove the cover of a bonded seat. The cover of a bonded seat cannot be installed again once it has been removed. If installation of a heating element assembly is to be attempted in this kind of seat, cut an opening in the foam bun large enough for the element to fit ½” underneath the cover. A professional should only attempt this, as mistakes often result in the replacement of the seat foam and cover.
- Check and determine that the heating elements will fit under the seat trim covers in the desired areas. The listing channels or the Velcro hold-downs should line up with the cutouts in the heating elements. This is not important if the heating elements do not cross over a listing channel or Velcro hold-down. See figure 3.

IF ABOVE CONDITIONS CANNOT BE MET, DO NOT ATTEMPT INSTALLATION.

- **To prevent OVERHEATING AND/OR A FIRE follow these instructions carefully:**
 - Remove paper adhesive liner from the cushion and back heating elements before installing them onto the foam bun. This is mandatory as the heating pattern is maintained by the adhesion of the heating elements to the foam bun of the seat. If the heating elements are not secured they could develop hot spots.
 - The paper liner is combustible and is not intended to be installed with the heating elements.
 - The Heating elements must not be folded into seat listing channels except where cutouts were designed into the element. Do not fold the heating elements against themselves.
 - Cushion and back heating elements are wired to operate in series only. Do not change the wiring to power the heating elements in parallel.

IN THE EVENT THAT THESE WARNINGS ARE DISREGARDED, THE WARRANTY BECOMES NULL AND VOID. MISUSE OF THIS PRODUCT MAY CAUSE SERIOUS INJURY TO PERSON OR PROPERTY.

- Installation -

- 1** Pre-wire all components on your workbench and test with a multi-meter for continuity. Do NOT use a battery charger as a power source. Use a 12V D.C. power source. If there are any problems, see the troubleshooting page. **IF THE KIT HAS A CUSHION AND BACK HEATING ELEMENT THEN BOTH MUST BE USED. NEVER OPERATE CUSHION OR BACK ELEMENT SEPARATELY. CHECK CORPORATION HAS SINGLE ELEMENT HEATERS AVAILABLE IF NEEDED.**
- 2** Locate vehicle fuse panel and determine routing of wire. Look for ignition switched fuses that are 15 Amps or greater. One fuse adapter can be used for only one module. Find location for controller and switch. Switch could be mounted on center console, dashboard, seat molding or using an optional switch bracket. Controller could be mounted under center console, or instrument panel. Secure controller with Ty-wraps.
- 3** Disconnect and isolate the negative (ground) battery cable, pump the brakes a few times, and wait five minutes for the system to discharge. It is important to do this before disconnecting any airbag connectors.
- 4** Remove Seat(s) from vehicle. Care should be taken, as the sharp edges of the seat frame will scratch the interior trim. Use duct tape or padding to cover sharp areas before removing seat.
- 5** Remove the seat covers and verify that the heating elements fit. **HEATING ELEMENT ASSEMBLIES SHOULD NEVER BE INSTALLED ONTO FOAM WHERE AN OCCUPANT DETECTION SENSOR IS VISIBLE ON THE TOP SURFACE OF THE FOAM. EVEN IF THE HEATING ELEMENT WOULD NOT TOUCH THE SENSOR.**
- 6** Install the ground wire ring terminal, from the power harness, to the fuse box ground screw. Clean terminals and grounding point of paint, grease, and dirt to ensure a good electrical connection. **NEVER DRILL THROUGH THE FLOOR.**
- 7** Install the seat heater switch with a 5/164" drill bit on the seat molding, the center console, dashboard, or using an optional switch bracket. Ensure that the wire harness will reach the switch and the wires aren't obstructed by the seat structure and supports. **NEVER PUT THE SWITCH IN A POSITION WHERE THE LIGHT FROM THE SWITCH WOULD GLARE INTO THE DRIVER'S OR OCCUPANT'S EYES.**
- 8** Locate area for heating elements by tracing element outline onto foam bun. Be sure that the cushion element is placed on the cushion bun, and that the back element is placed on the back bun.
- 9** Remove the adhesive release paper. This paper must be removed, as IT WILL BURN. Attach the heating elements to the foam bun (not the seat cover) by pushing down on the pads causing the adhesive to stick completely to the foam bun. **NOTE:** Element may be hard to handle if you tear release paper off all at once. Paper can be peeled away in increments as you apply the element to the foam bun. Apply cushion element rear to front and back element bottom to top. **RELEASE PAPER MUST BE COMPLETELY REMOVED. FAILING TO COMPLETELY REMOVE PAPER IS A FIRE HAZARD AND VOIDS WARRANTY.**
- 10** Re-install seat trim covers. Do not install hog rings through the heating element. **THE SEAT LISTING WIRES SHOULD NOT LIE DIRECTLY ON TOP OF THE HEATING ELEMENTS. IF THE LISTING WIRES MUST CROSS THE PADS IN THE CHANNELS, ADD SOME FOAM FOR PROTECTION.**
- 11** Install the seat into the vehicle. Reconnect airbag connectors and then the ground of the battery. Connect the extension harnesses to the controller as shown in the wiring diagram. Remove the fuse that was located in step 2, and reconnect using the supplied fuse adapter. Only one module per fuse adapter. ***SEE FUSE INSTALLATION***
- 12** Mate all remaining connectors (as shown in the wiring diagram). **SECURE THE WIRE WITH THE TIES PROVIDED. CHECK THAT THE RECLINING OF THE SEATS, OR THE MOVEMENT OF THE SEAT FRAME DOES NOT PULL, FRAY, OR CUT THE WIRES**
- 13** **TEST SEAT FUNCTIONS; RECLINE, FORWARD, REVERSE, UP, DOWN, ETC. MAKING SURE THAT NO STRAIN IS PLACED ON ANY OF THE SYSTEM'S WIRES.** Make sure all of the anchor bolts are tight to the manufacturer's specification.
- 14** **OPERATION OF THE HEATED SEATS:** After turning the system on, you must sit in the seat and should be able to feel heat within 1-5 minutes depending on the thickness of the trim cover material over the element. The thicker the trim cover, the longer it takes to feel the heat.

LUX-1XX SEAT HEATER KIT WIRING DIAGRAM

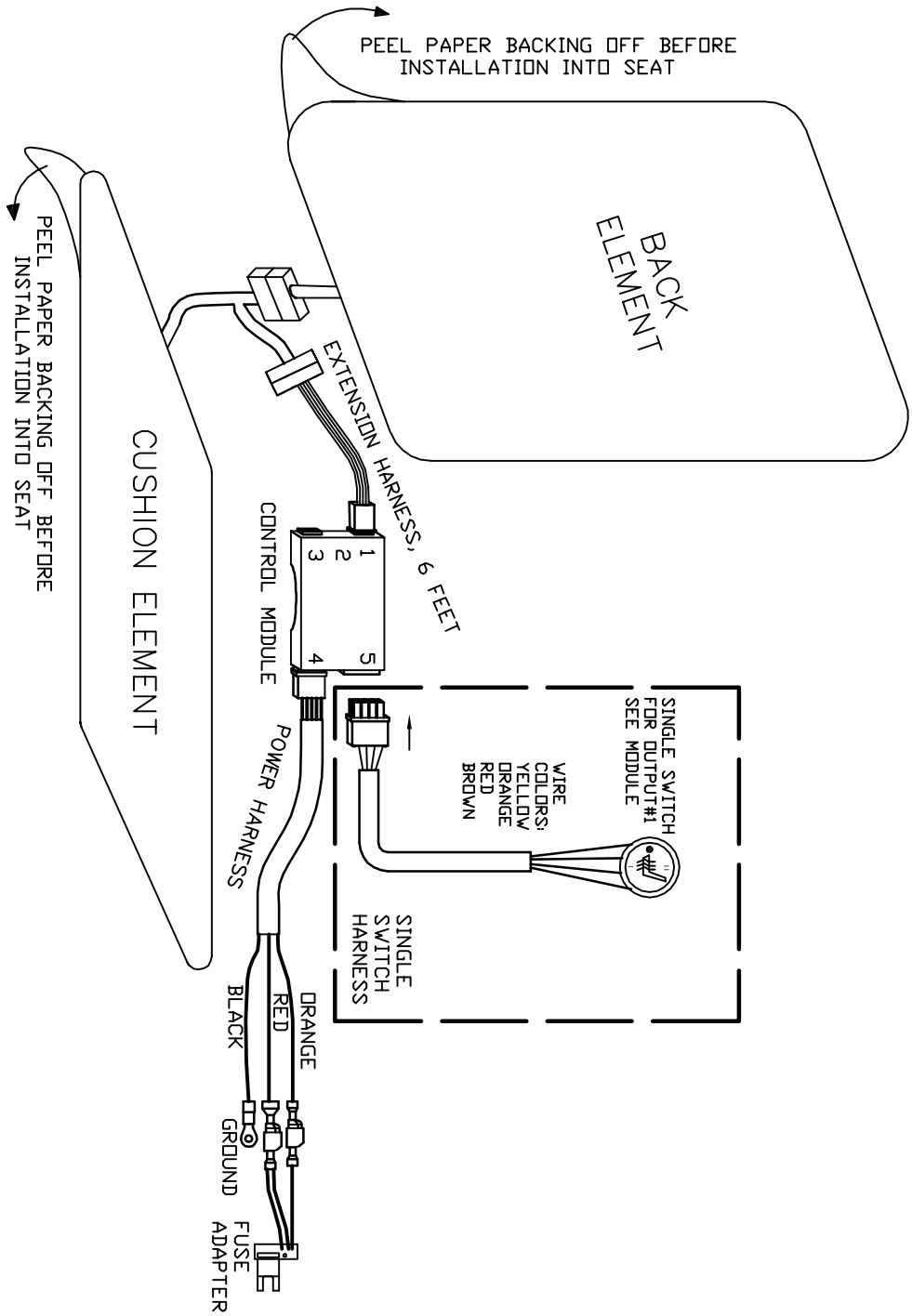

SWITCH OPENING

5/164" Drill Bit with
3/8" Shank available
from Advantage
ADV/PLEX385164
PHONE 407-678-1177

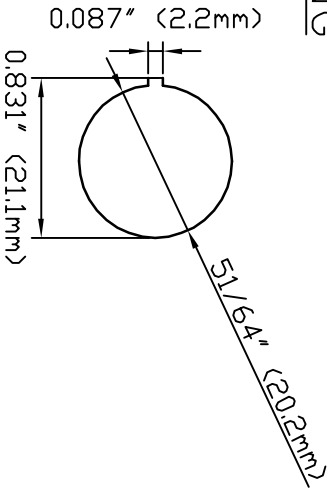

LUX-2XX SEAT HEATER KIT WIRING DIAGRAM

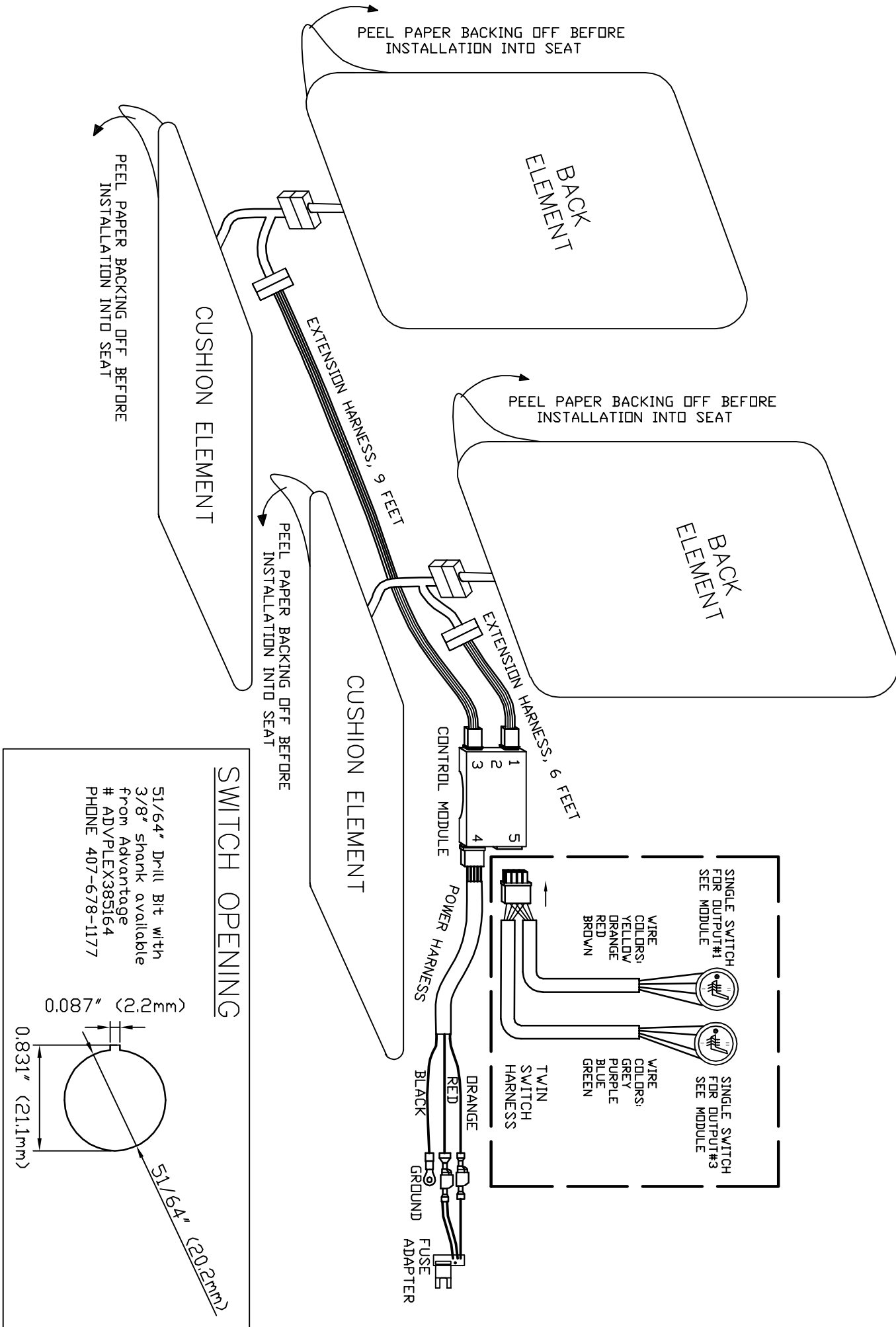

PEEL PAPER BACKING OFF BEFORE INSTALLATION INTO SEAT

PEEL PAPER BACKING OFF BEFORE INSTALLATION INTO SEAT

PEEL PAPER BACKING OFF BEFORE INSTALLATION INTO SEAT

SWITCH OPENING

51/64" Drill Bit with 3/8" shank available from Advantage # ADV/PLEX385164 PHONE 407-678-1177

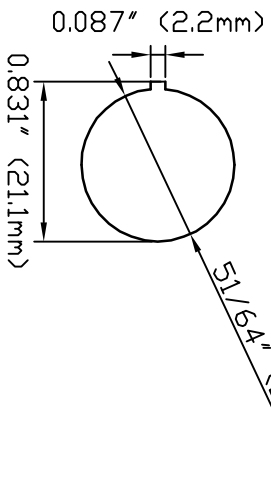

LUX-3XX SEAT HEATER KIT WIRING DIAGRAM

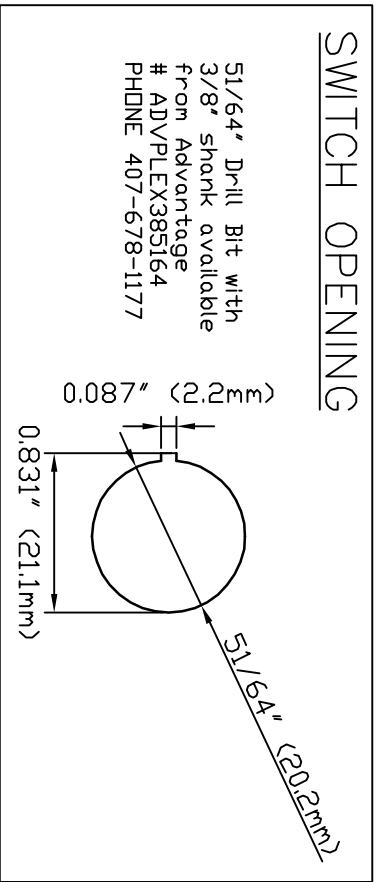
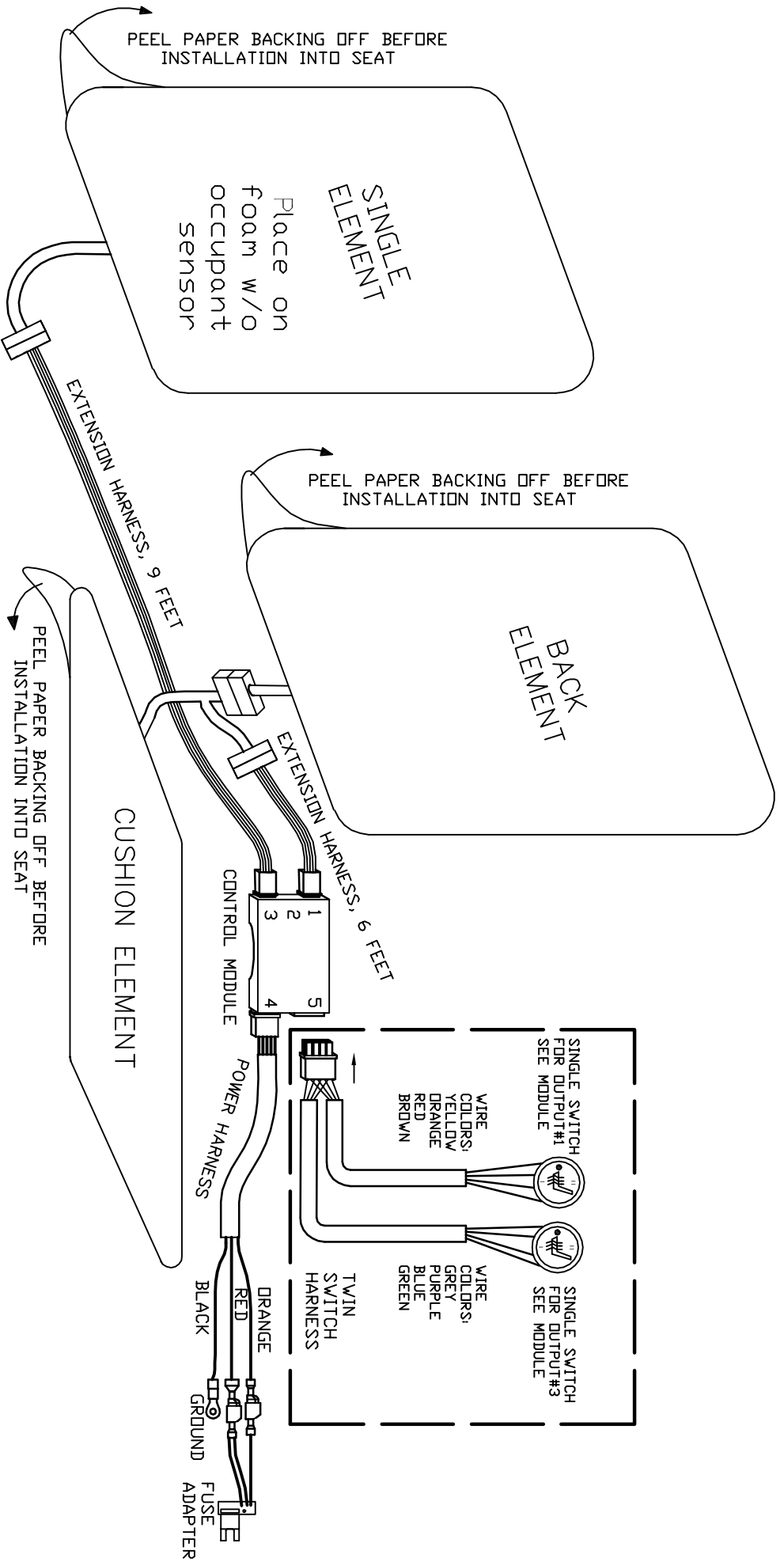

- Fuse Installation -

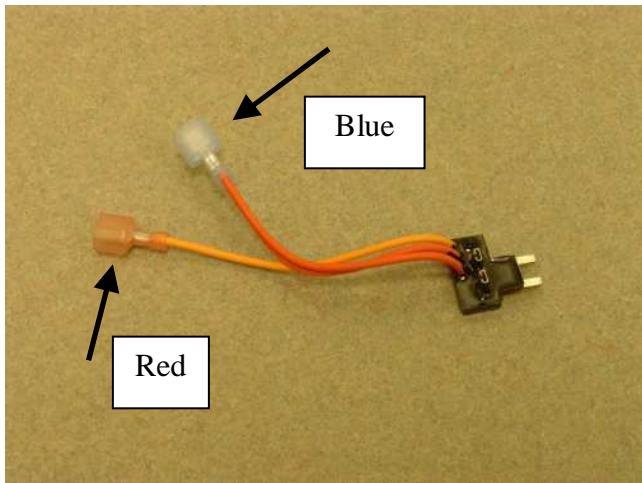

1) Fuse adapter. The terminals connect with the matching color terminal on the power harness.

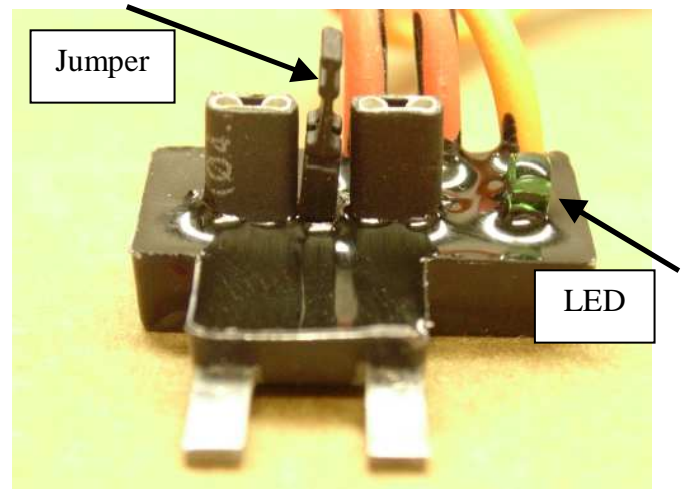

2) When the fuse adapter is inserted correctly, with the jumper in place the green LED will be on.

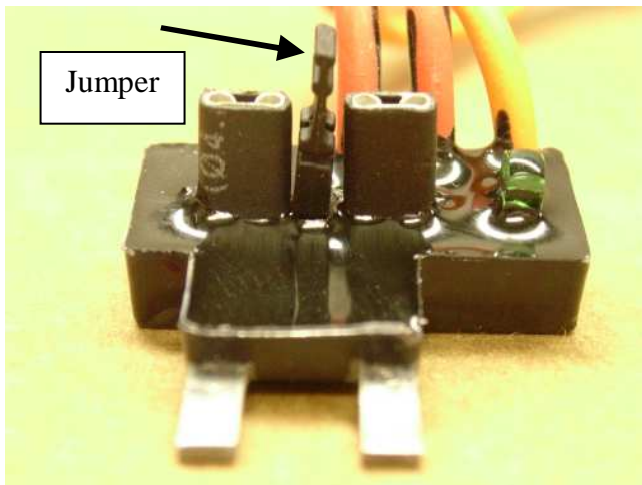

3) You **MUST** remove the jumper before inserting the fuse.

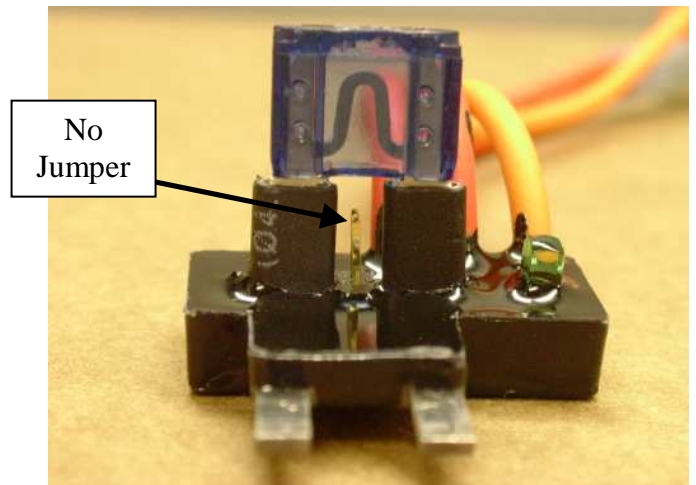

4) The fuse correctly inserted into the fuse adapter. The Led will be off when the fuse is inserted into the adapter.

- Troubleshooting of the Electrical System -

If the system does not heat up, check the following:

To test the unit you must sit in it for at least a 5-minute period in which the heat has time to reach the seat surface.

- Check the fuse in the fuse adapter added during the installation.
- Ensure that all connections are properly mated and that the 12V DC and ground wires are properly installed. (See wiring diagram)

If the heating elements, switch, and seat harness test OK, then a power problem exists, check the following:

- Using a multi-meter or a test light, start at the fuse adapter and trace back through all of the connectors and the switch to determine where the power loss is occurring. Repair as necessary.

If the fuse continues to fail, check the following:

- The fuse adapter may be connected wrong. To test this, remove the fuse and place the jumper back into the fuse adapter. If the fuse adapter is connected correctly the green LED should be illuminated. If it is not illuminated, remove the fuse adapter, rotate it and reconnect.
- Each pair of heating elements that are installed in the vehicle must have their own fuse. Each pair of heating element assemblies must be connected to their own fuse adapter at the fuse panel.

If the LED on the switch is ON more than it is OFF, check for the following:

- A break in the heating element circuit. To check for this, pull on the brown, blue & yellow wires at all connectors to verify they are properly seated in the connector. Don't forget the connector on the back element. Also check for continuity at the 4 pin connector. The cushion and back elements must be connected and use a multi-meter set to ohms. See Figures 1-2.
- A low voltage condition on the controller input from the fuse box. To verify the voltage input, use a multi-meter set to volts, across red AND black wires at controller module (it should read 11-14V).
- A poor ground connection. Check connections or try another grounding point. Another possible cause is the fuse used for power is computer controlled (try another fuse). If a new installation the control module is probably working fine. Disconnect power to reset controller and clear old faults.

If the LED on the switch is OFF more than it is ON, check for the following:

- There is a problem with the heat sensor circuit. Pull on grey & green wires at connectors to verify that they are properly seated in the connector. If possible swap in another control module to see if the LED's are still flashing. If so, then the problem is inside the cushion element (replace). If a new installation the control module is probably working fine. Make sure power is off to controller when changing it out.

IF YOU HAVE ANY QUESTIONS REGARDING THE INSTALLATION OF CHECK CORPORATION SEAT HEATERS, PLEASE CALL OUR HOTLINE AT 1-800-927-6787, 8AM TO 5PM EASTERN STANDARD TIME.

- Figures -

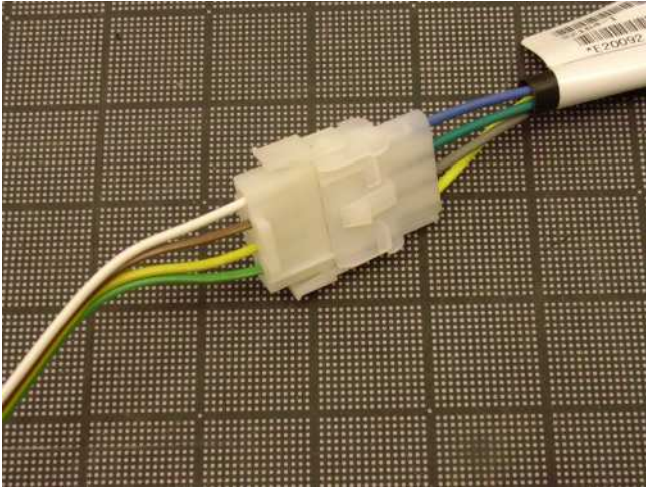

1) This is the 4 Pin connector at the end of the element harness. Disconnect the bonded wire harness and use a multi-meter to check for continuity.

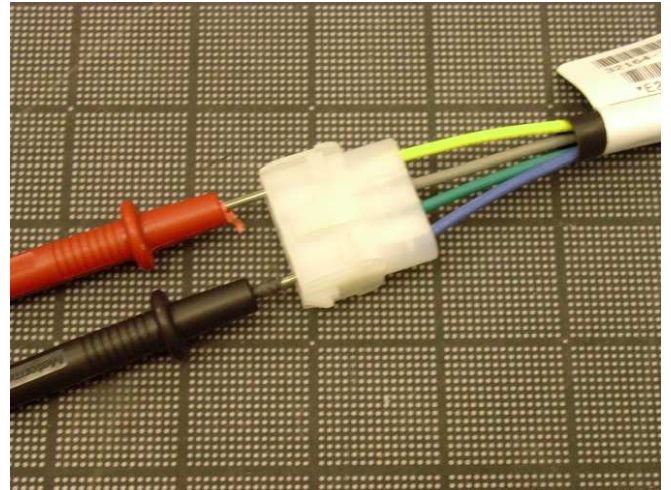

2) Set the multi-meter to ohms, and touch the red and black probes to the yellow and blue pins. The meter should show that there is continuity through the heating wire; if it does not, there is a break in the heating wire.

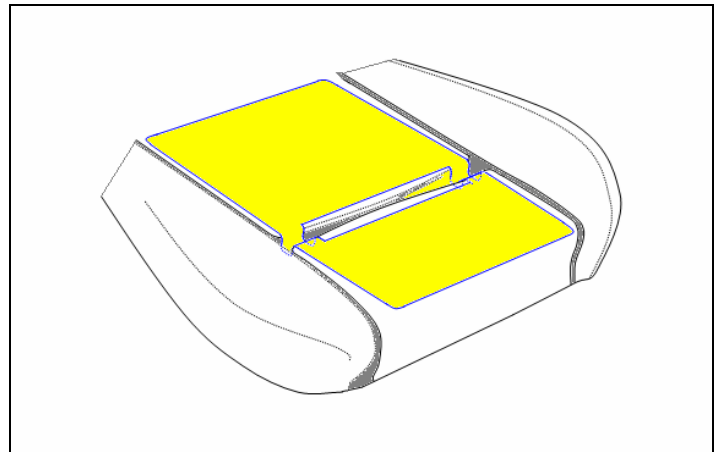

3) The listing channels or the Velcro hold-downs should line up with the cutouts in the heating elements. Seat heater adheres 100% to the foam bun following the surface into the listing gaps. Opening in heater is aligned with gap.